

目 录

一、运输作业组织与管理模块..... 2

二、仓储与配送作业组织与管理模块..... 34

三、国际物流作业组织与管理模块..... 150

四、 快递物流作业组织与管理模块.....	213
-----------------------	-----

湖南商务职业技术学院物流管理专业学生技能考核题库

一、运输作业组织与管理模块

○

○

○

--	--	--

○

○

--	--	--	--	--

() 任务描述

○

:

○

○



<input type="checkbox"/> <input type="checkbox"/>				<input type="checkbox"/> <input type="checkbox"/>				
<input type="checkbox"/> <input type="checkbox"/>								
						<input type="checkbox"/> <input type="checkbox"/> <input type="checkbox"/> <input type="checkbox"/>		



() 任务描述:

-
-
-



QUESTIONNAIRE

/				/	v

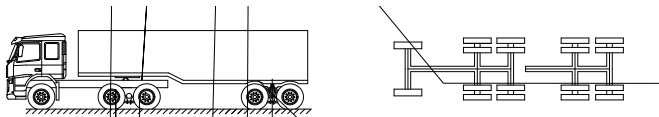
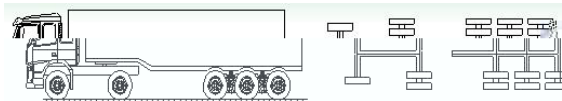

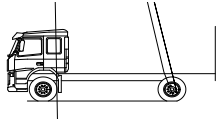
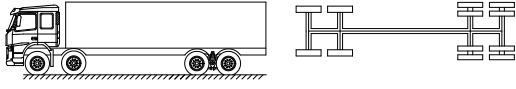
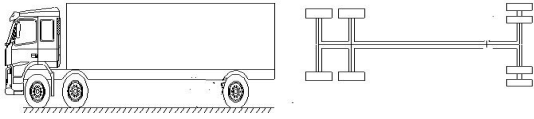

() 任务描述:



○

○

○

○

○

() 任务描述



D

<input type="checkbox"/> <input type="checkbox"/>			<input type="checkbox"/> <input type="checkbox"/>						
<input type="checkbox"/> <input type="checkbox"/>									
						<input type="checkbox"/> <input type="checkbox"/> <input type="checkbox"/> <input type="checkbox"/>			





2

3

4

() 任务描述

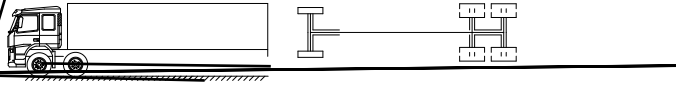
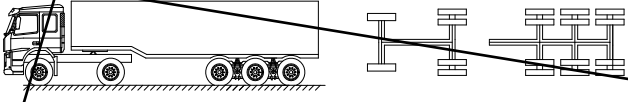
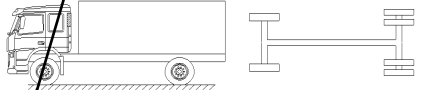
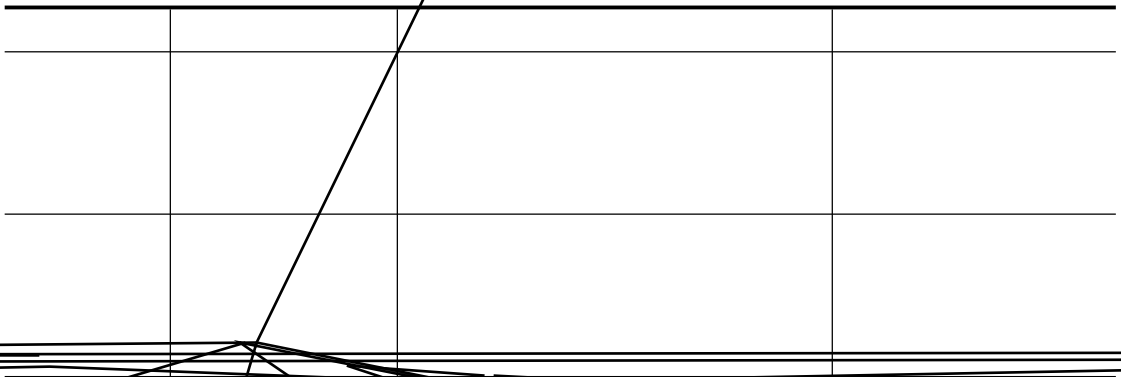



() 任务描述

-
-
-
-
-

() 任务描述

HF

1

GUANGZHOU HF Trading CO., LTD.

Room 502, No.838, Dongfeng Road, Guangzhou, China

TEL: 020-87656751 FAX: 020-87656772

2

AL QADAH TRADING COMPANY L.L.C

202 W. 1st St. LOS ANGELES, CA 90012

Phone (877) 554-4000 Fax (213) 237-3535

3

PRODUCT: CLEANING BALL

PARTIAL SHIPMENT allowed

TRANSSHIPMENT : allowed

		CARTONS)	(CBM)			

4 TIME OF SHIPMENT () 2016 5 15

5 SERVICE TYPE () CY/CY

6 FREIGHT () PREPAID

7 PORT OF LOADING () SHENZHEN

8 PORT OF DISCHARGE () LOS ANGELES

9

USD1450/20GP, USD1800/40GP, USD1800/40HQ



*SHIPPER : ()	/		
	*		
	*	*	
	*		
*CONSIGNEE	* /		
	*		
NOTIFY PARTY:			-
* /	*	*	*
	*	*	*

MARK NUMBERS											DESCRIPTION OF GOODS											KGS		KGS		CBM	
√																											
*											√																
											CY/CY √																
											CFS/CY																
											CFS/CFS																



Sailing Schedule from : Shenzhen,Shenzhen,Guangdong,China

To : Los Angeles,Los Angeles,CA,United States

Origin City : Shenzhen,Shenzhen,Guangdong,China

Destination City : Los Angeles,Los Angeles,CA,United States

CY/DOOR

CY/DOOR

序列号	航线	船名	航次	截关时间	装货港	预计离港时间	实际离港时间	卸货港
1	YPSW	YM UNISON	59E	2016-04-22 17:00	Yantian	2016-04-25		Los Angeles
2	SEA	NORTHERN JAVELIN	002E	2016-04-23 12:00	Yantian	2016-04-27		Long Beach
3	AAS2	CMA CGM LIBRA	095TXE	2016-04-25 16:00	Yantian	2016-04-28		Long Beach
4	YPSW	YM UBIQUITY	22E	2016-04-29 17:00	Yantian	2016-05-02		Los Angeles
5	SEA	C SCL PUSAN	117E	2016-04-30 12:00	Yantian	2016-05-04		Long Beach
6	AAS2	CMA CGM COLUMBA	097TXE	2016-05-02 16:00	Yantian	2016-05-05		Long Beach
7	SEA	COSCO NINGBO	069W	2016-05-06 11:00	Yantian	2016-05-08		Long Beach
8	YPSW	YM JIREBY...	50E	2016-05-06 17:00	Yantian	2016-05-09		Los Angeles
9	SEA	COSCO EXCELLENCE	027E	2016-05-07 12:00	Yantian	2016-05-11		Long Beach
10	AAS2	CMA CGM CENTAURUS	099TXE	2016-05-09 16:00	Yantian	2016-05-12		Long Beach
11	YPSW	YM MASCULINITY	32E	2016-05-13 17:00	Yantian	2016-05-16		Los Angeles
12	SEA	HONG KONG BRIDGE	039E	2016-05-14 12:00	Yantian	2016-05-18		Long Beach
13	AAS2							



干货箱



	箱体内部尺寸			箱体内容积及载重量		箱门开度尺寸	
	L	W	H	Cu	P	W	H
20'	5898	2352	2393	33.2	21740/28230#	2340	2280
40'	12032	2352	2393	67.7	26630	2340	2280
HC	12032	2352	2698	76.3	26520	2340	2585

冷藏箱



	箱体内部尺寸			箱体内容积及载重量	
	L	W	H	Cu	P
20'	5444	2284	2267	28.5	21135/27160#
40'	11583	2284	2250	58.7	26580
HC	11583	2284	2650	67.9	26380

开顶箱



	箱体内部尺寸			箱体内容积及载重量	
	L	W	P	Cu	P
20	5900	2330	2337	32.6	21740
40	12025	2330	2337	65.8	26410

○

○

() 实施条件

() 考核时量

() 评分细则

1

		10			
				5	

				10 5	
				10 5	

() 任务描述



		<input type="checkbox"/>	<input type="checkbox"/>	<input type="checkbox"/>	<input type="checkbox"/>

<input type="checkbox"/> <input type="checkbox"/> <input type="checkbox"/> <input type="checkbox"/>							



”

() 实施条件

() 考核时量

() 评分细则

		1			
				10 5	
				5	
		10			

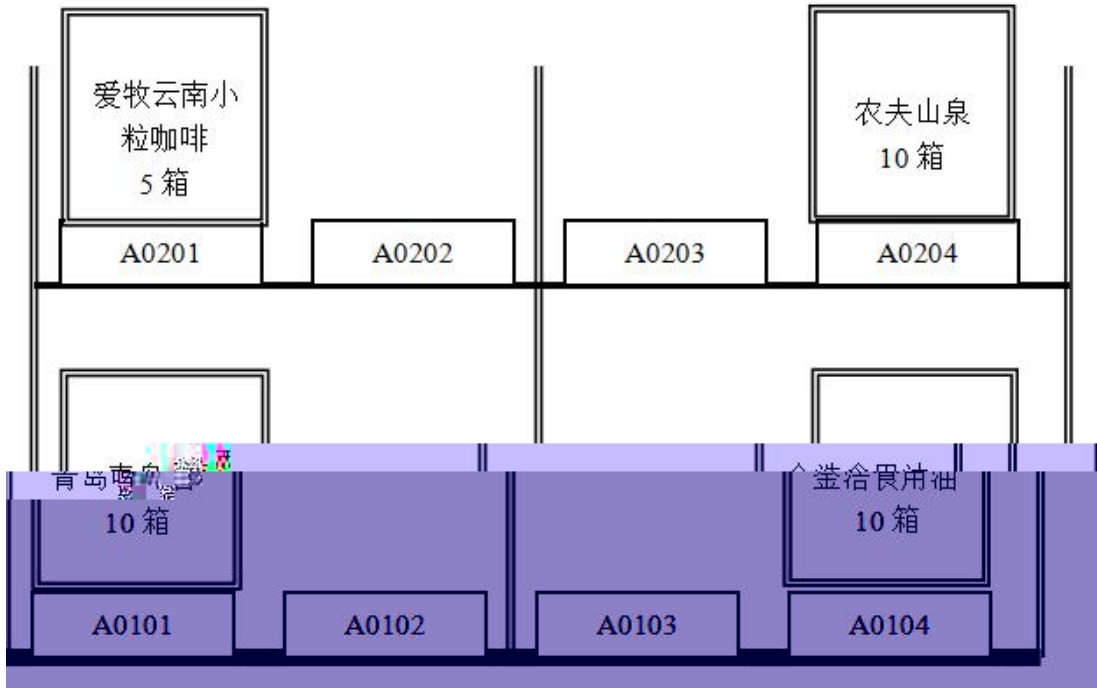

产品运输单

-
-
-
-
-
-
-
-

80				

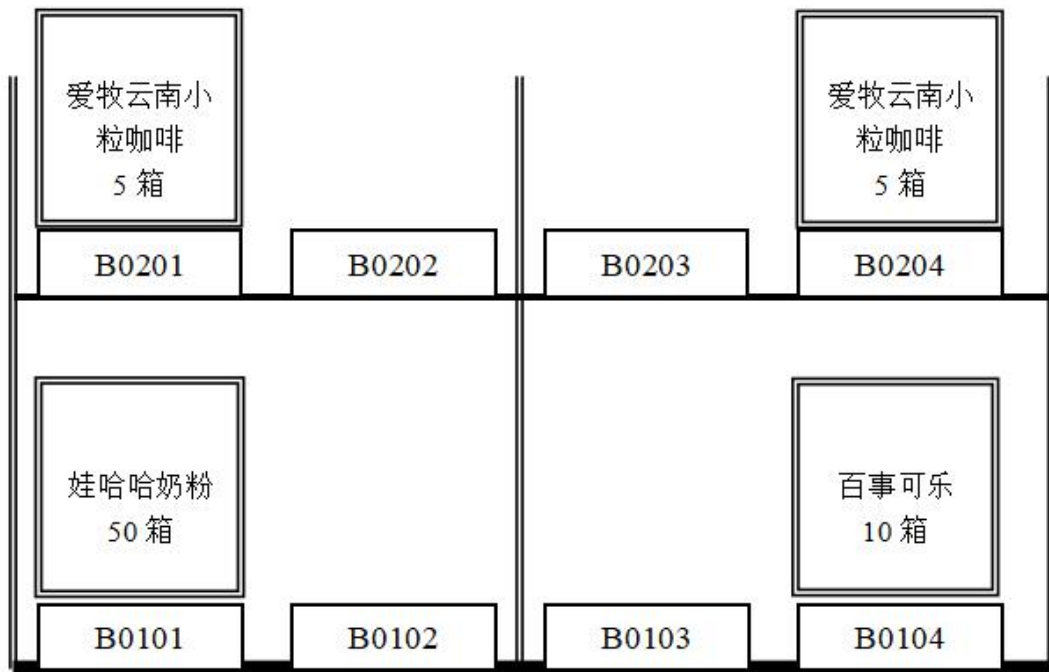
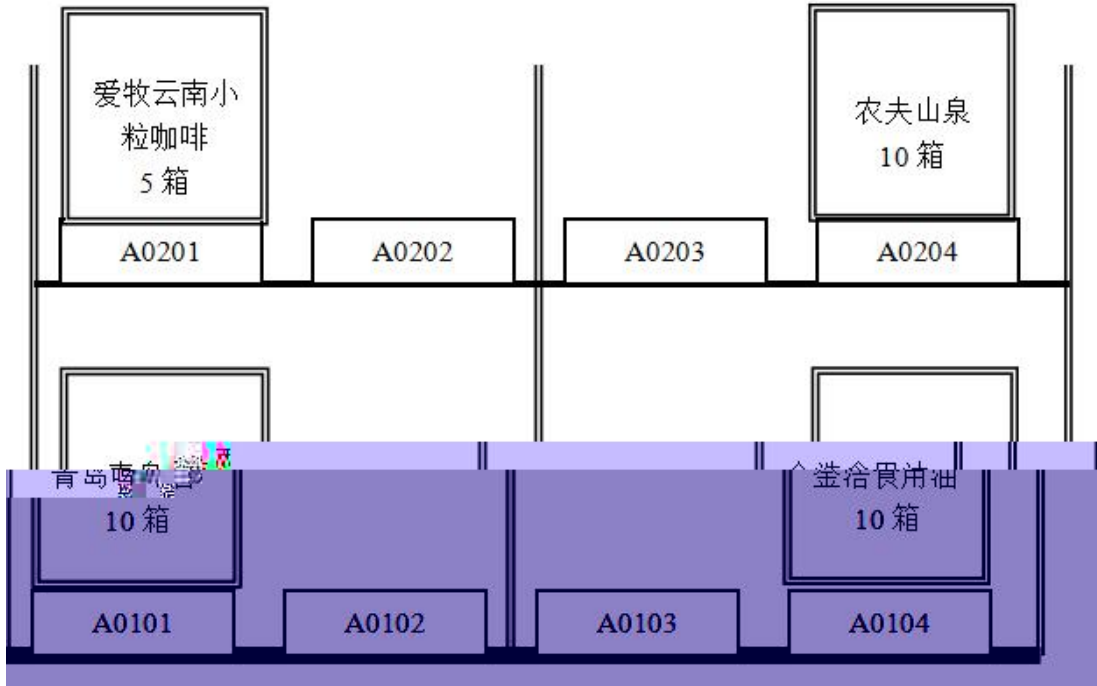

产品运输单

-
-
-
-
-
-
-
-

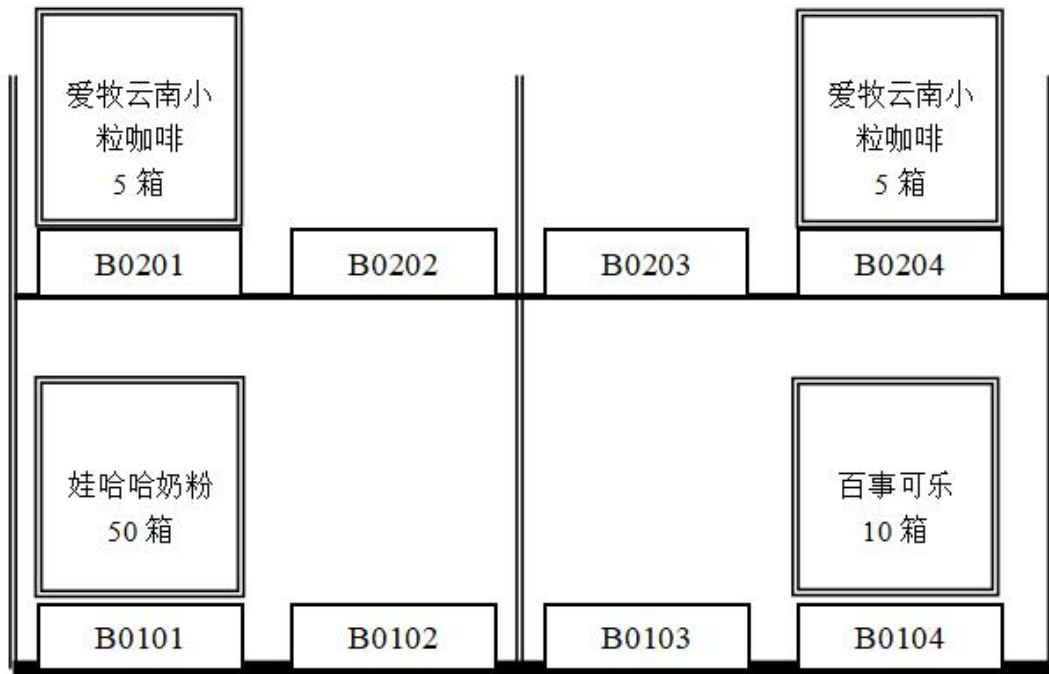
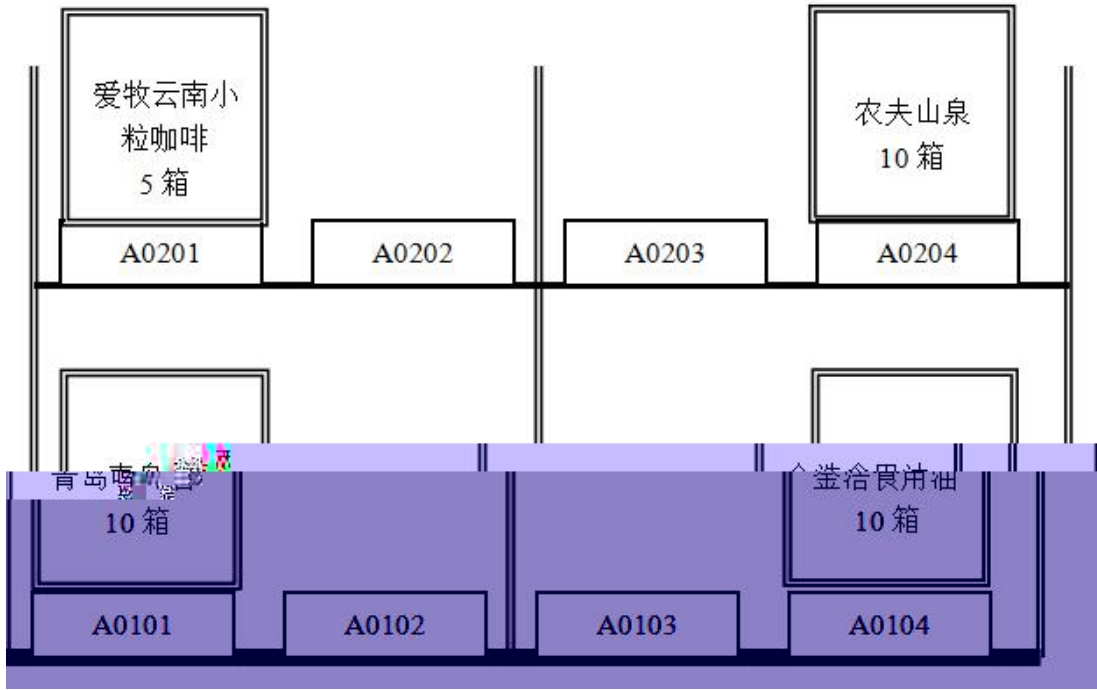

产品运输单

-
-
-
-
-
-
-
-



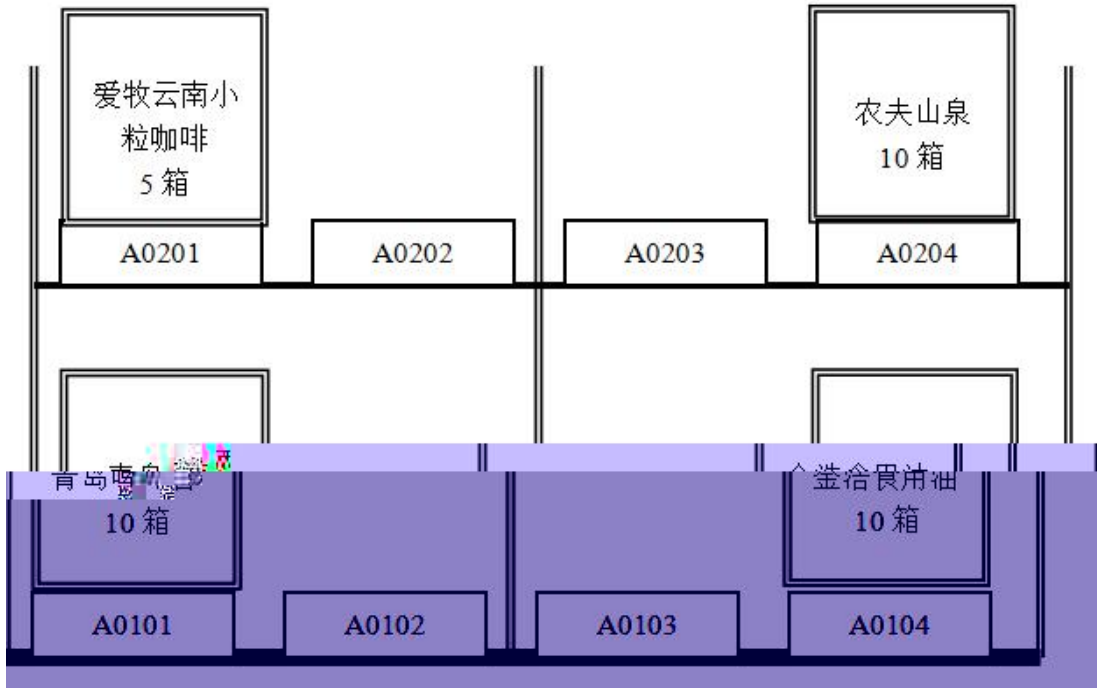

产品运输单

-
-
-
-
-
-
-
-

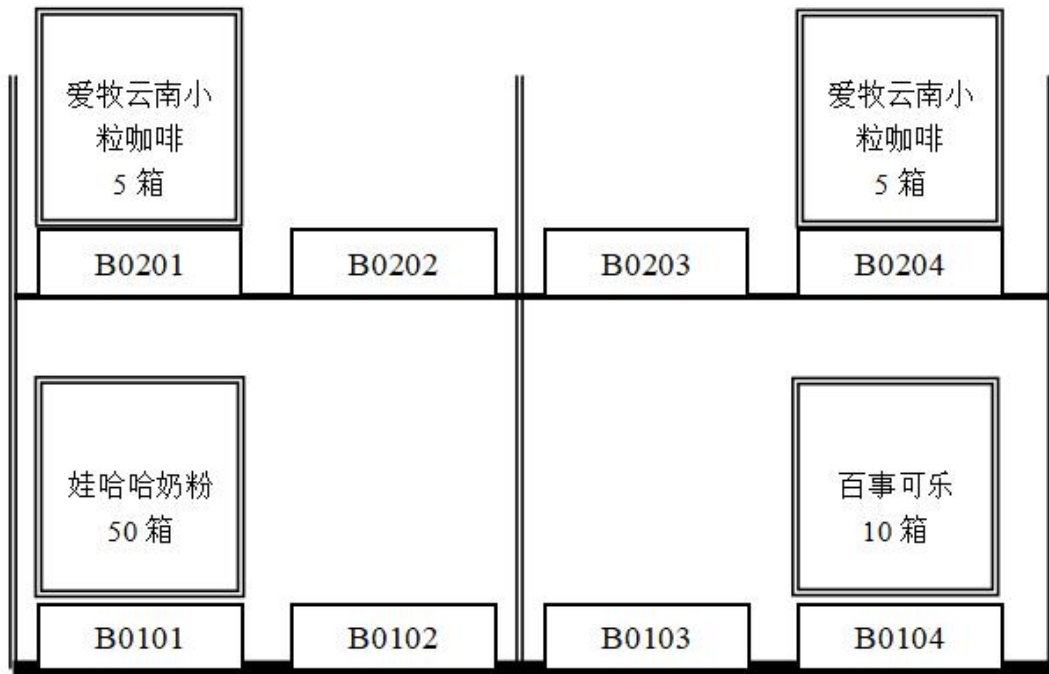
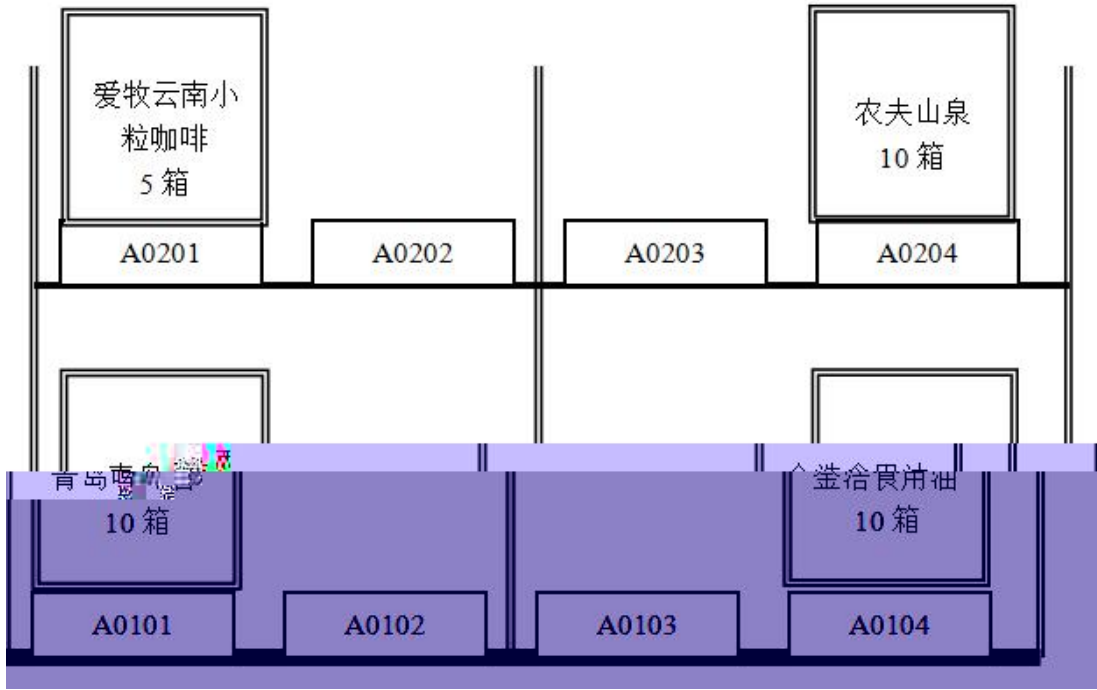

产品运输单

○

○

○

○

○

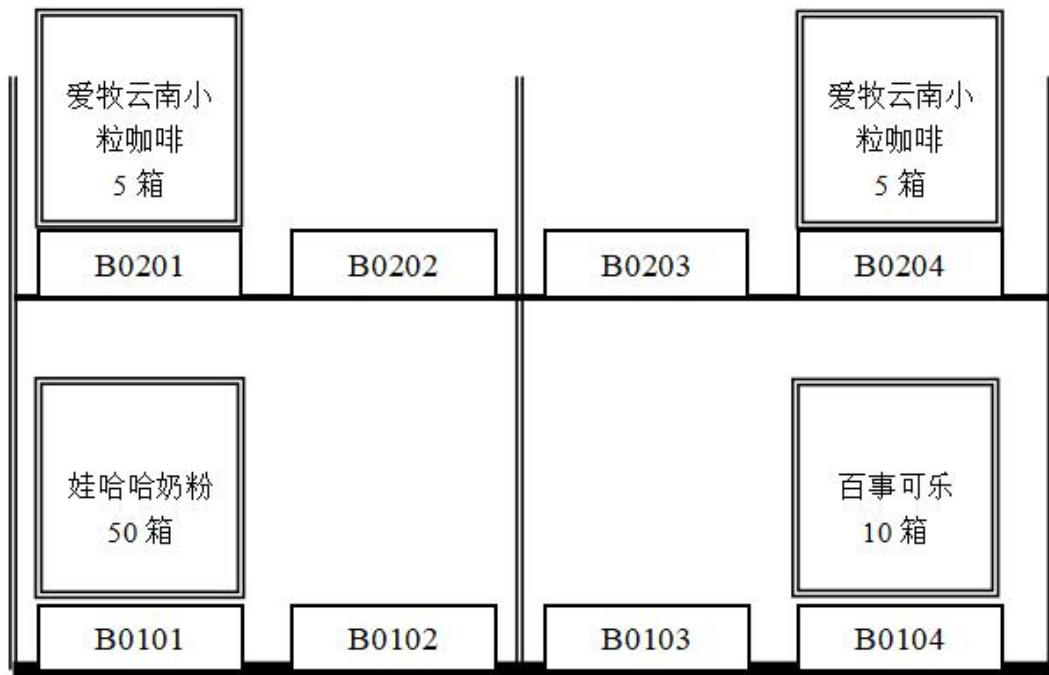
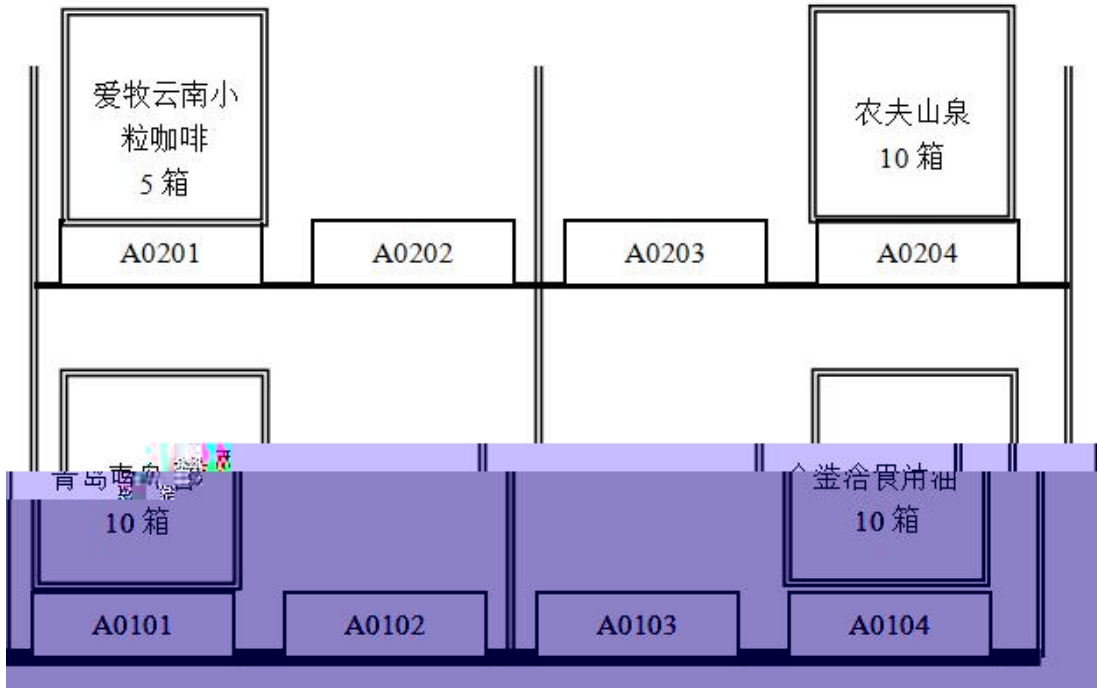

产品运输单

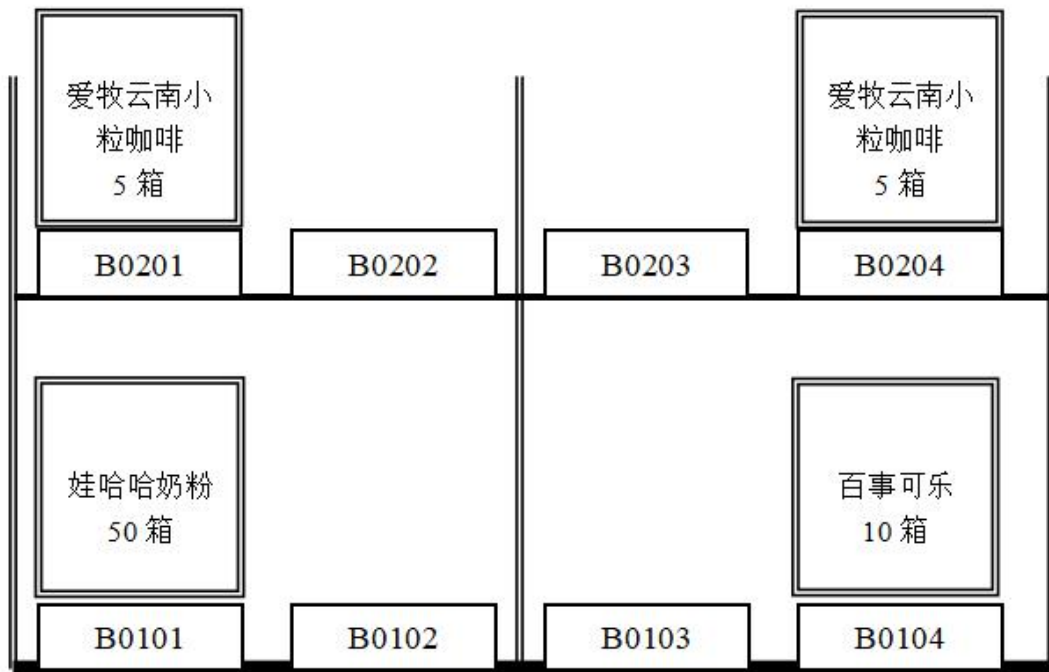
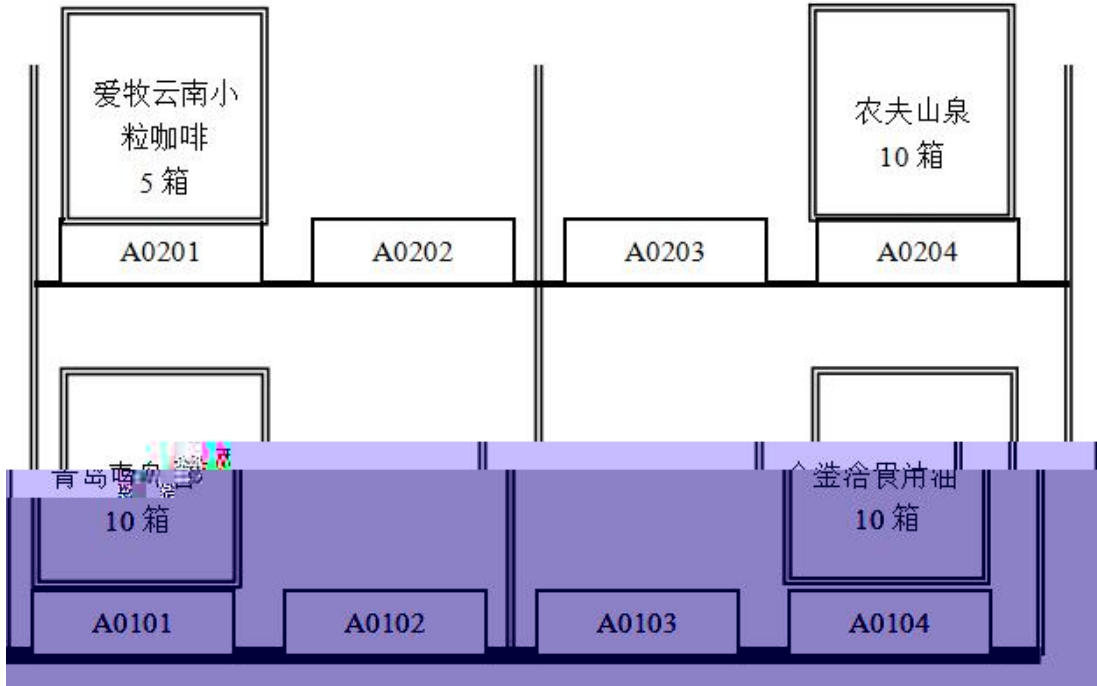

产品运输单

-
-
-
-
-
-
-
-
-

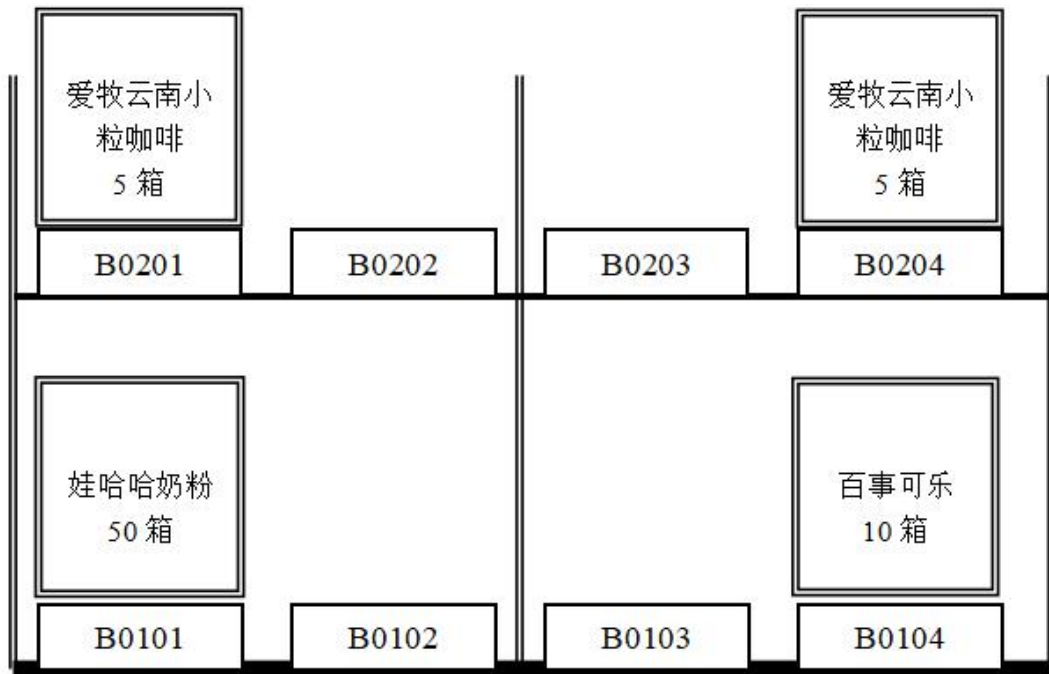
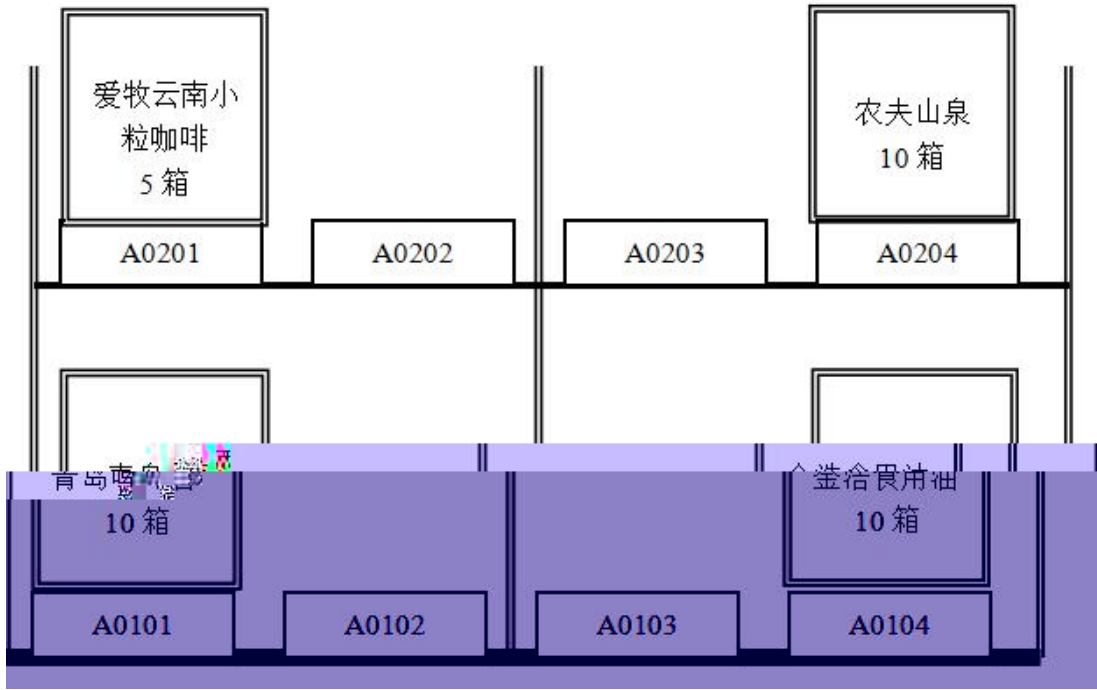

产品运输单

-
-
-
-
-
-
-
-
-

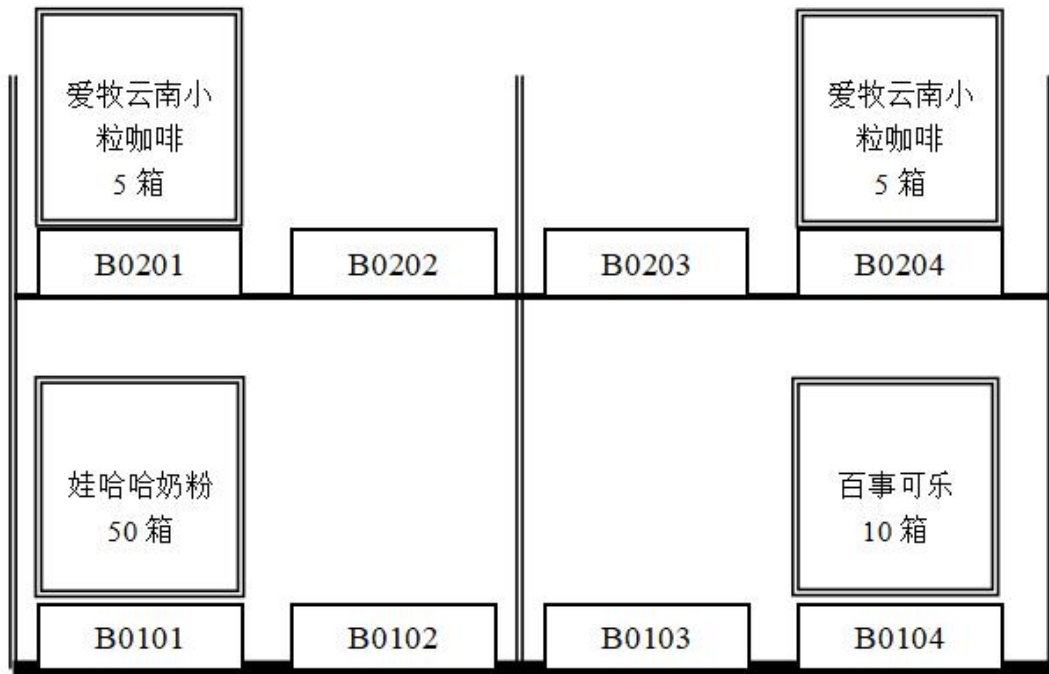
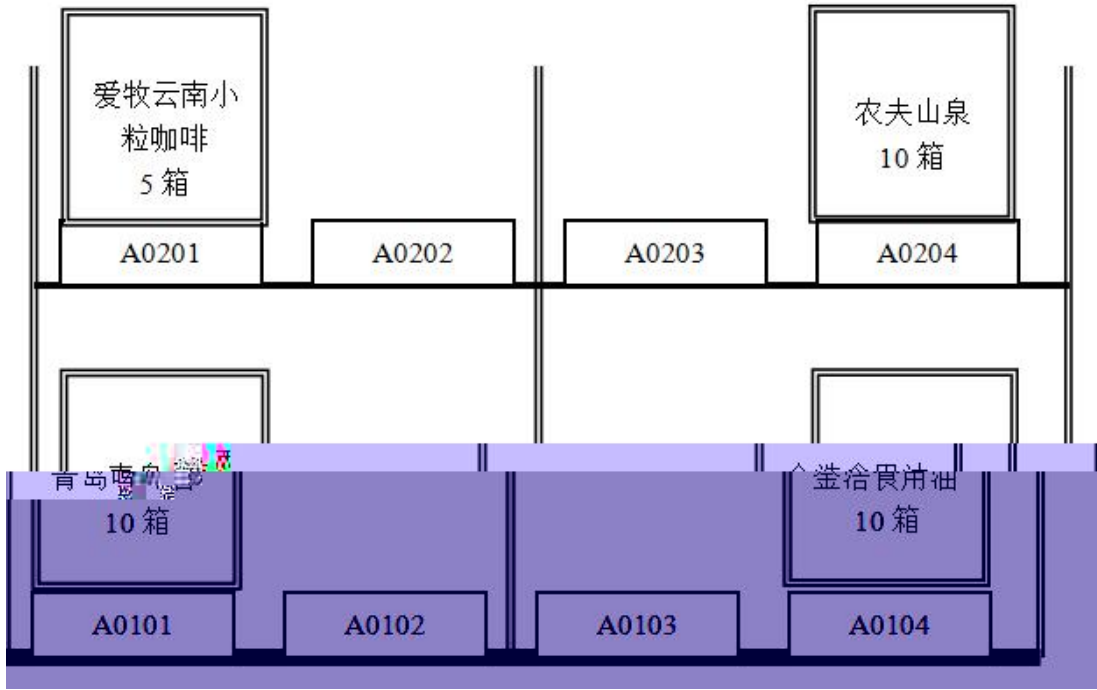

产品运输单

-
-
-
-
-
-
-
-

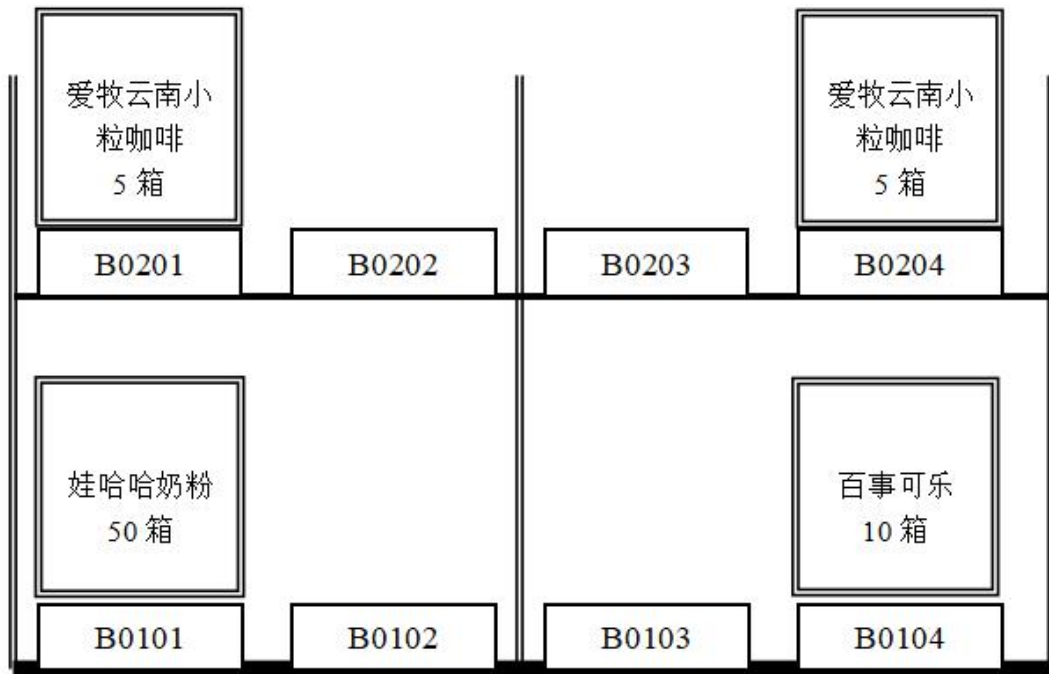
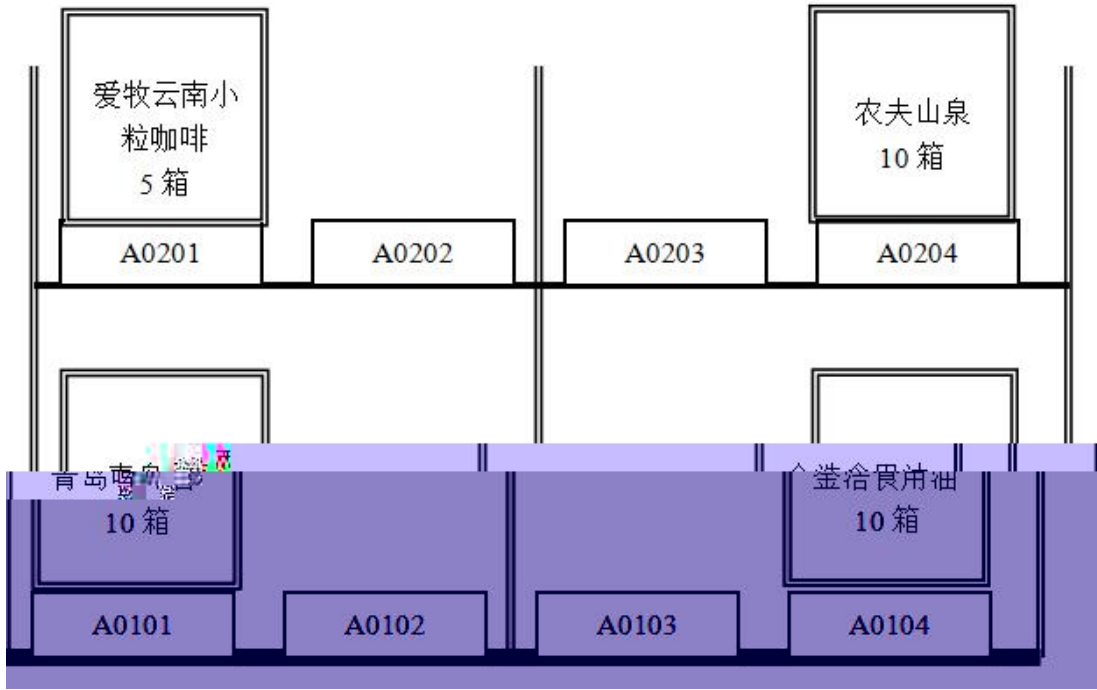

产品运输单

-
-
-
-
-
-
-
-

○

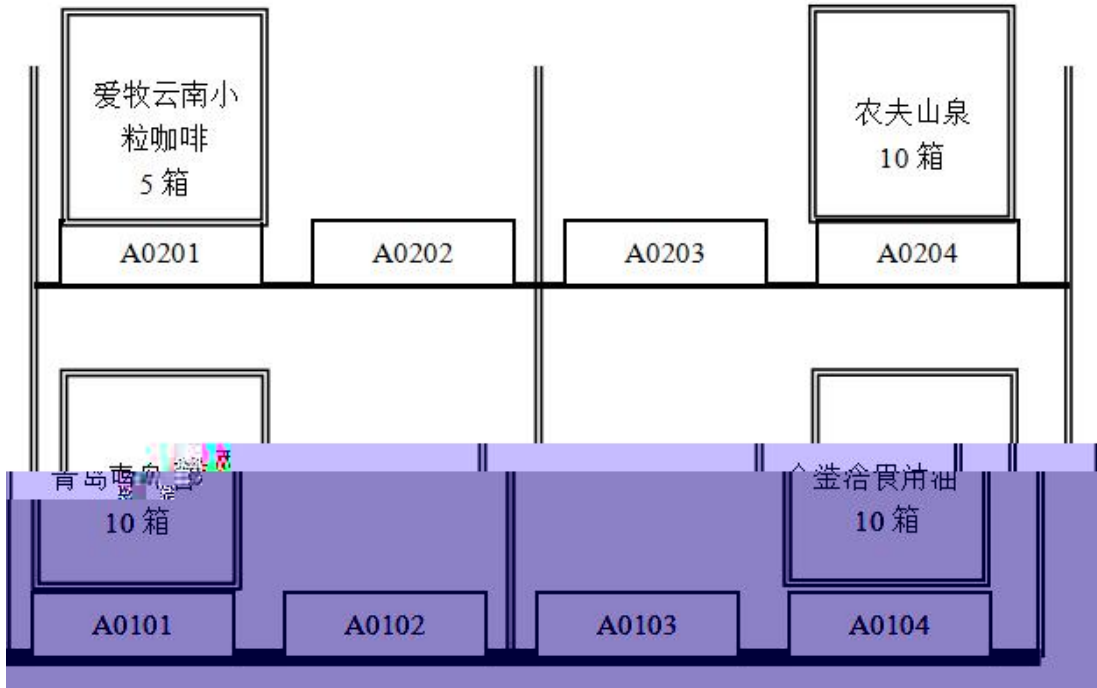



--	--	--	--	--	--

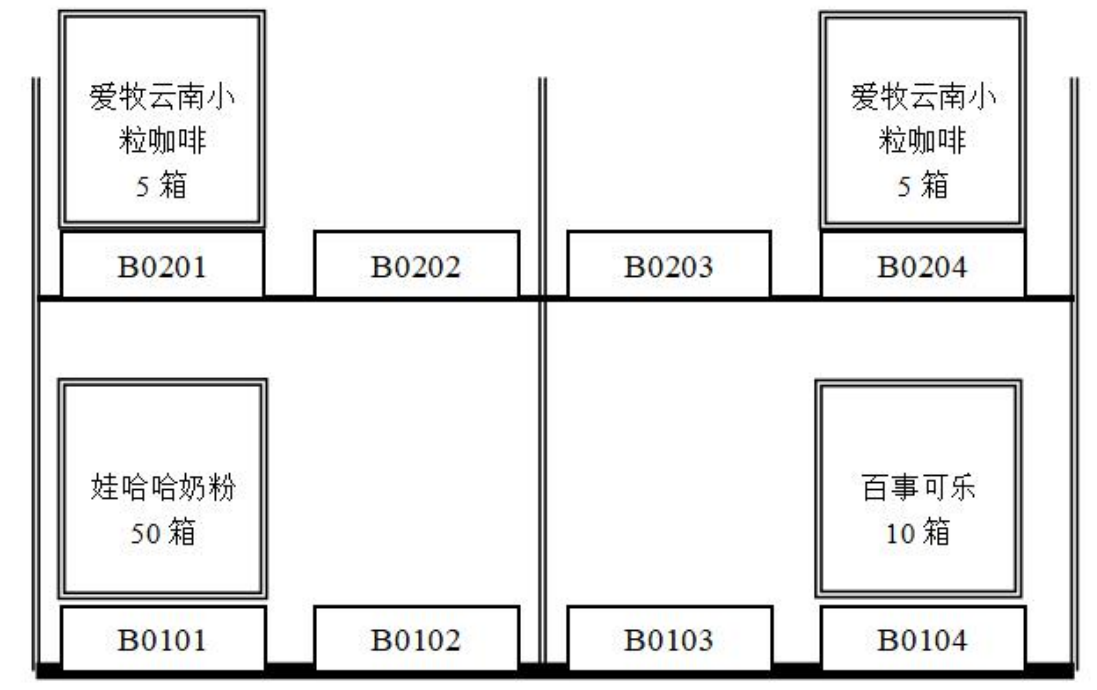
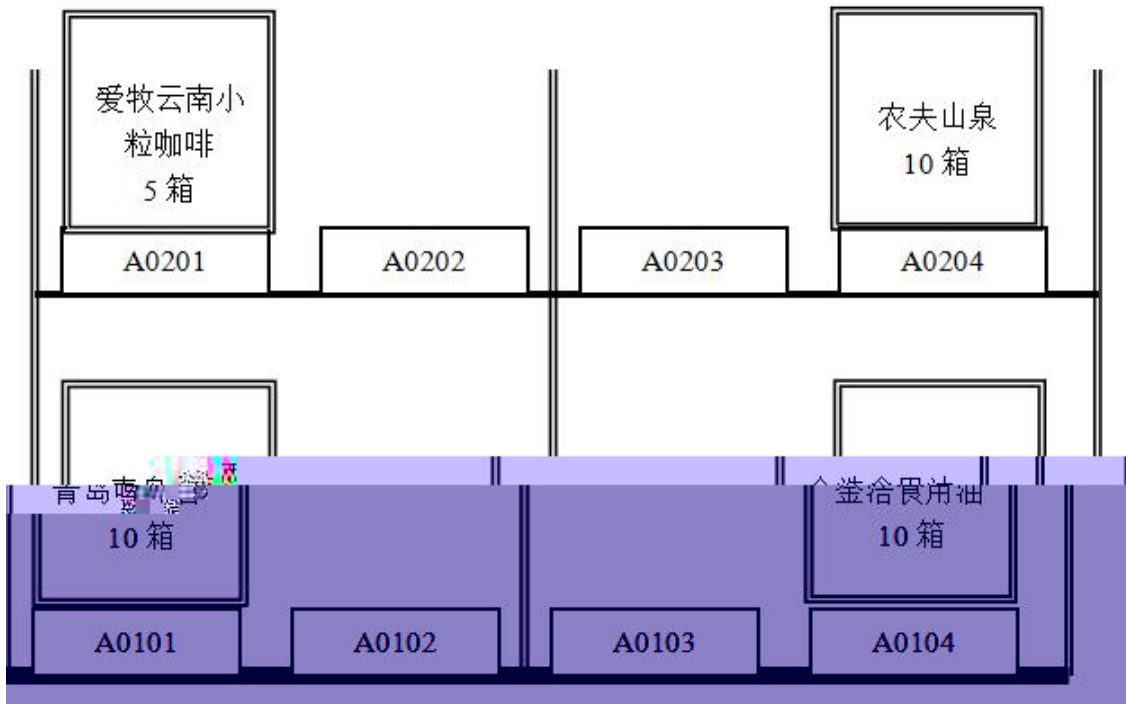

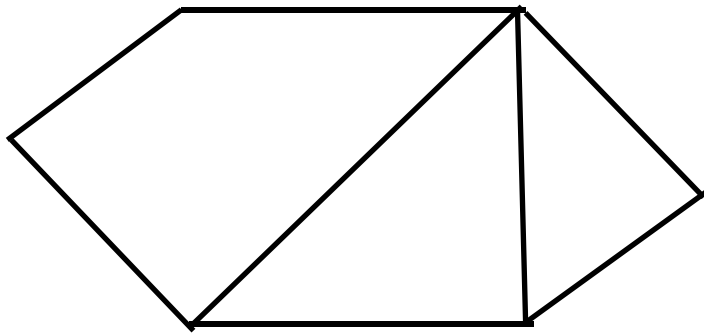

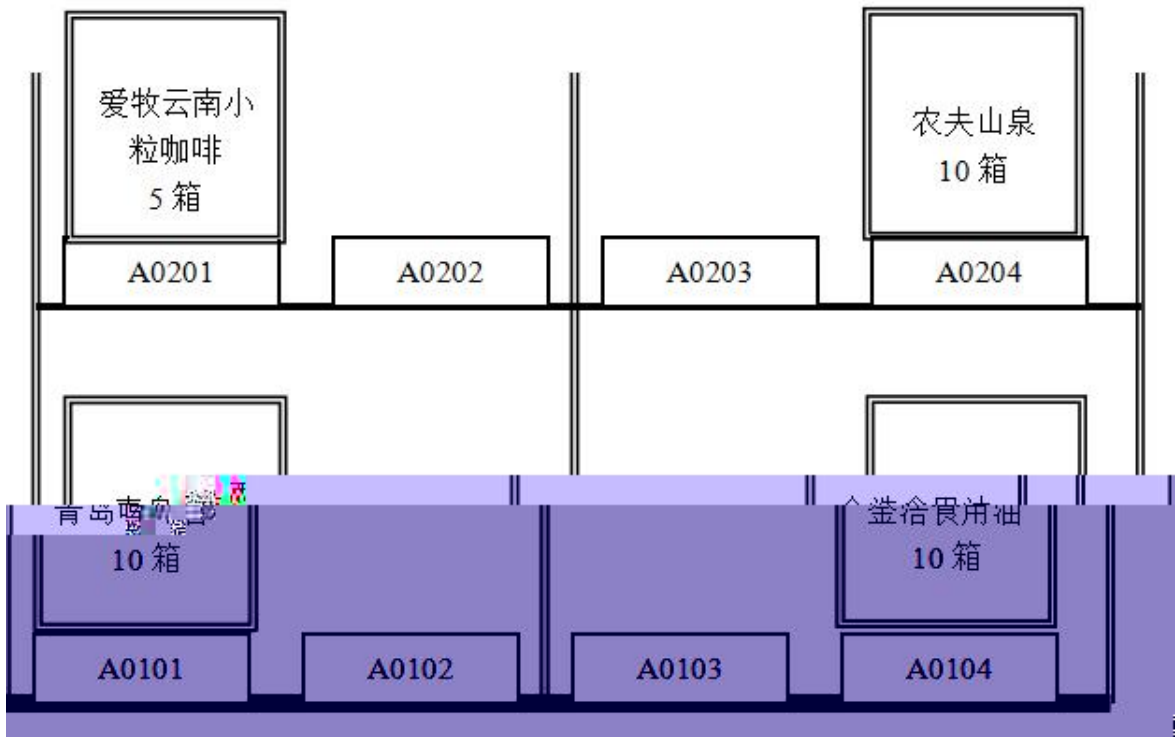



1

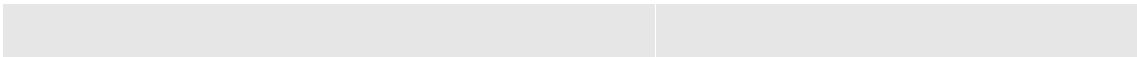

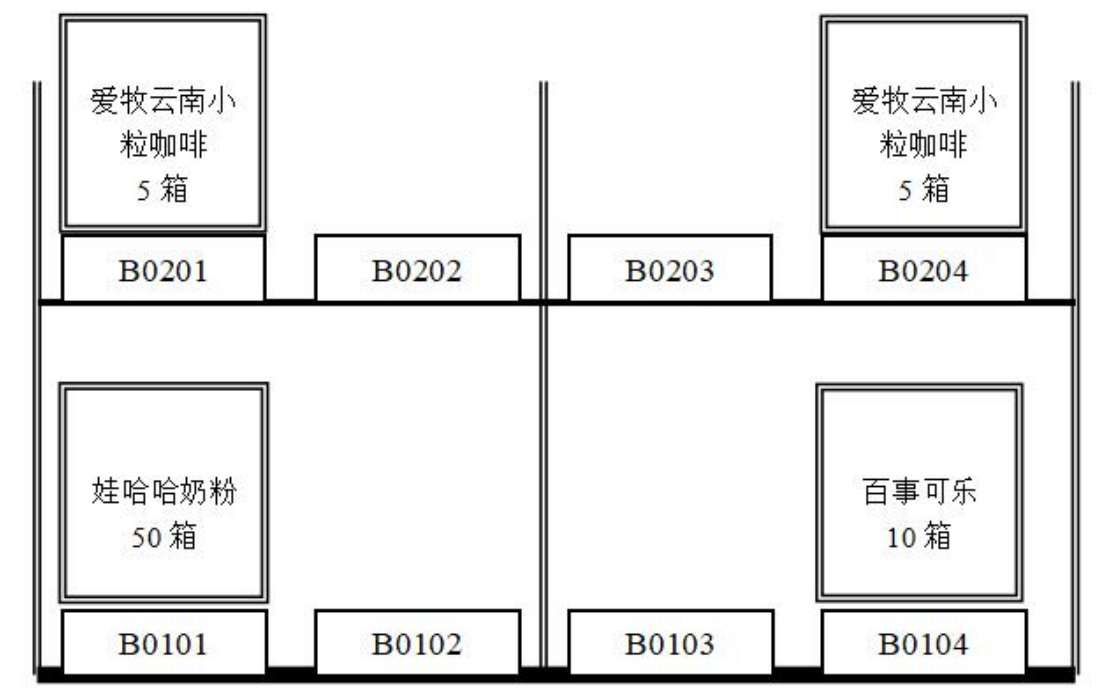
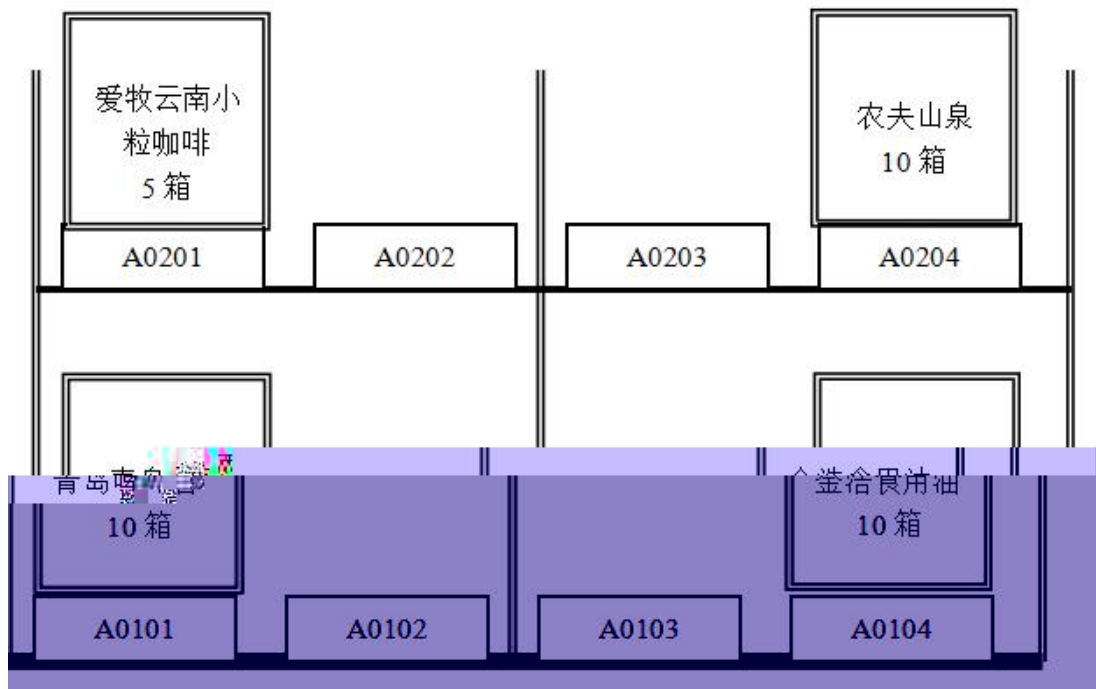

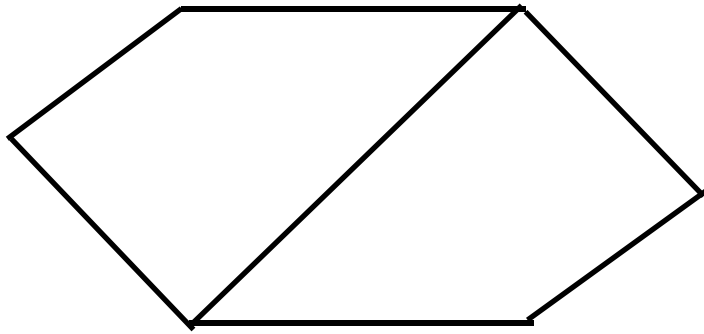

1

--	--	--	--	--	--

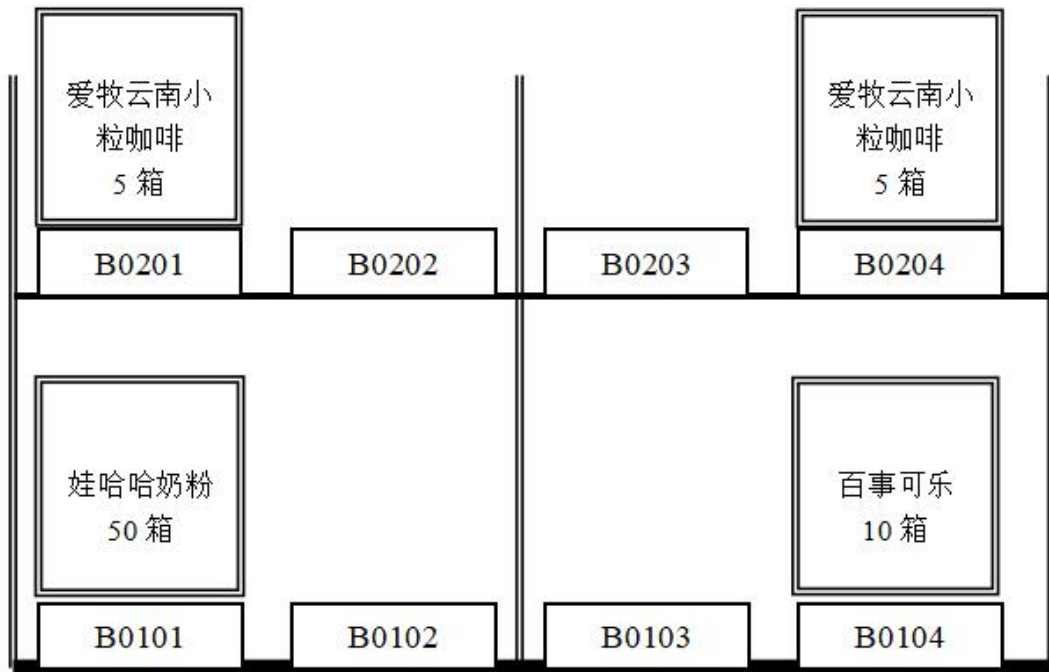
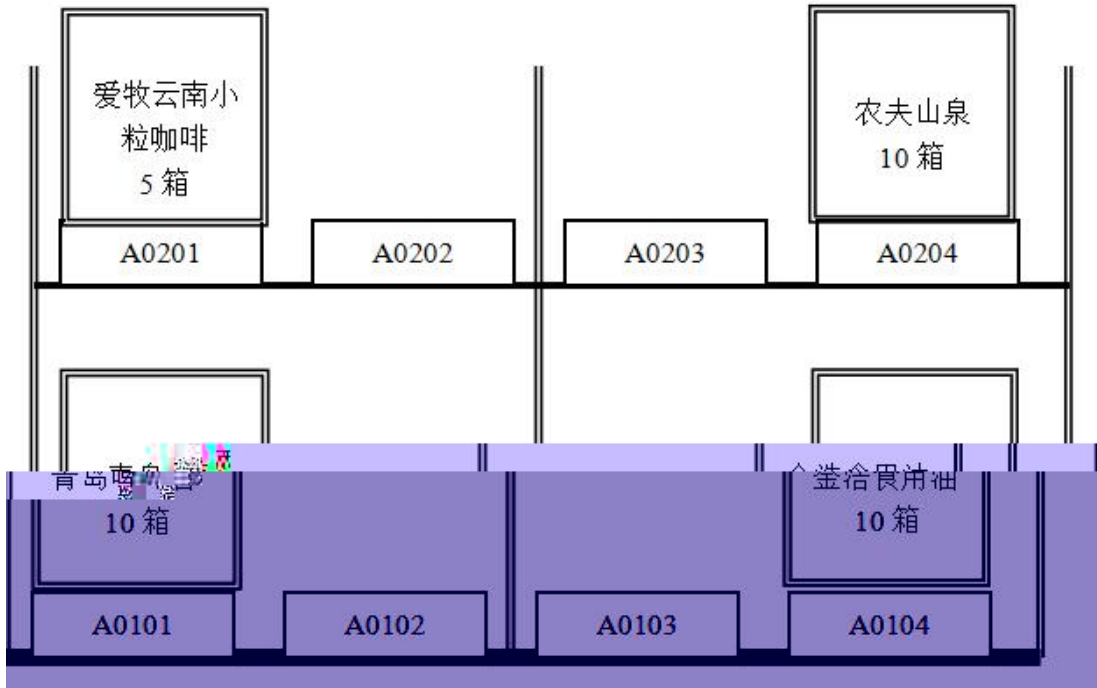

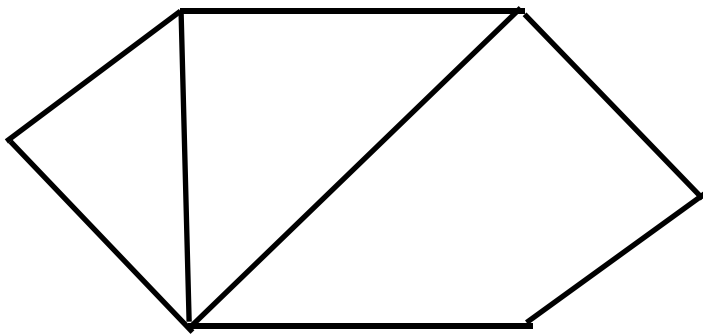

○

○

○

○

○

○

○

○

--	--

○

○

三、国际物流作业组织与管理模块

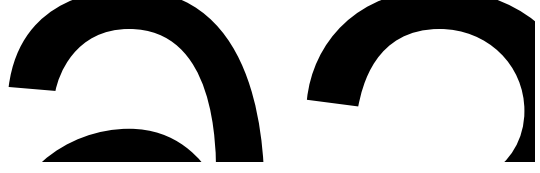

○



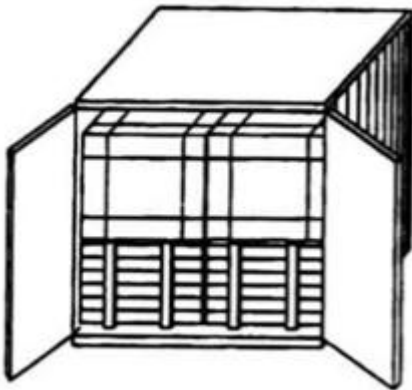
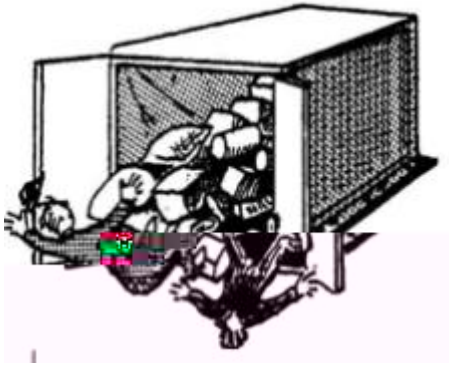
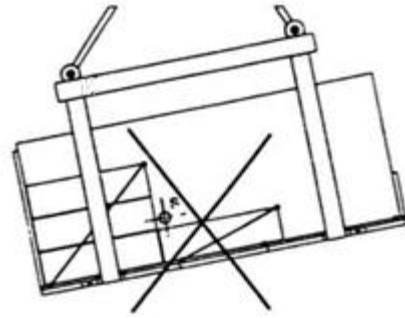

○

船公司	船名/航次	服务代码	航线	装船港/卸船港	启-达日期	天	挂港
Carrier			Lane	Load/Unload Port	ETD-ETA		Day
MSC	MASTER			HONG KONG 香港	02/25 (二)		
地中海航运	409E			KAOHSIUNG 高雄	03/15 (六)		
10	NYK	ITALIAN EXPRES		HONG KONG 香港	02/25 (二)		
日本邮船	S/024		中国-东南亚	BANGKOK 曼谷	03/02 (日)		
5	CMA-CGM	CMA CGM GEMINI		XIAMEN 厦门	02/25 (二)		
达飞轮船	TXA49E		中国-非洲	DURBAN 德班	03/27 (四)		
30	KLINE	HYUNDAI PLATINU		SHANGHAI 上海	02/25 (二)		
川崎汽船	M/004W		中国-中南美	PARANAGUA 巴拉那瓜	04/09 (三)		
43	DMS	COSCO KAOHSIUN		HONG KONG 香港	02/25 (二)		
达发轮船	G/GFS46E		中国-澳新	NOUMEA 努美阿	04/02 (三)		
36	RCL	KOTA PERMASAN		QINGDAO 青岛	02/28 (五)		
长海轮运	VPM114		中国-中东/波斯湾/印巴	MADRAS 马德拉斯	03/18 (二)		
18	ZIM	KUO HUNG	CHINA_VIETN	NINGBO 宁波	02/25 (二)		
以星轮船	311	AM(CVX)	中国-港澳台	HONG KONG 香港	03/15 (六)		
18	SAFMARINE	HEIKE P		KAOHSIUNG 高雄	02/25 (二)		
比利时商航	1404		中国-非洲	MINDELO	04/05 (六)		
39	CSAV	CAP SAN NICOLA		SHANGHAI 上海	02/25 (二)		
南美邮船	S/01409		中国-中南美	RIO GRANDE 里奥格兰德	04/07 (一)		
41	OOCL	DRESDEN EXPRES	Pacific Atl	SHANGHAI 上海	02/25 (二)		
东方海外	S/16E08	antic (PAX)	中国-美东	HALIFAX 哈利法克斯	04/14 (一)		

○
○

BEIJING	CN		BJ\$
Y. RENMINBI	CNY		KGS
		100	10000
		200	20000
		300	30000
		400	40000
		500	50000

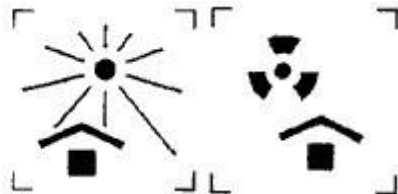

○

○

○

集装箱设备交接单
EQUIPMENT INTERCHANGE RECEIPT

OUT 出场

No.

用箱人/运箱人(CNTR. USER/HAULIER)		提箱地点(PLACE OF DELIVERY)	
发往地点(DELIVERED TO)		返回/收箱地点(PLACE OF RETURN)	
船名/航次(VESSEL/VOYAGE No.)	集装箱号(CNTR. No.)	尺寸/类型(SIZE/TYPER)	营运人(CNTR. OPTR)
箱号(No.)	箱号(No.)	箱封号(SEAL No.)	免费期限(FREE TIME PERIOD)
货重(CARGO W.)		出场目的/状态(PPS OF GATE-OUT/STATUS)	进场目的/状态(PPS OF GATE-IN/STATUS)
		出场日期(TIME-OUT) 月 日 时	
出场检查记录(INSPECTION AT THE TIME OF INTERCHANGE)			
普通集装箱(GP. CNTR.)	冷藏集装箱(RF. CNTR.)	特种集装箱(SEL. CNTR.)	发电机(GEN. SET)
<input type="checkbox"/> 正常(SOUND) <input type="checkbox"/> 异常(DEFFECTIVE)	<input type="checkbox"/> 正常(SOUND) <input type="checkbox"/> 异常(DEFFECTIVE) 记录温度(RECORDED)	<input type="checkbox"/> 正常(SOUND) <input type="checkbox"/> 异常(DEFFECTIVE)	<input type="checkbox"/> 正常(SOUND) <input type="checkbox"/> 异常(DEFFECTIVE)
损坏记录及代号(DAMAGE CODE)			



--	--	--	--	--	--

--	--	--

--	--	--	--	--	--

--	--	--	--	--	--

--	--	--	--	--	--	--	--

○





○

--	--	--

--	--	--	--	--	--

○

○

○

○

四、 快递物流作业组织与管理模块

--	--	--	--	--	--

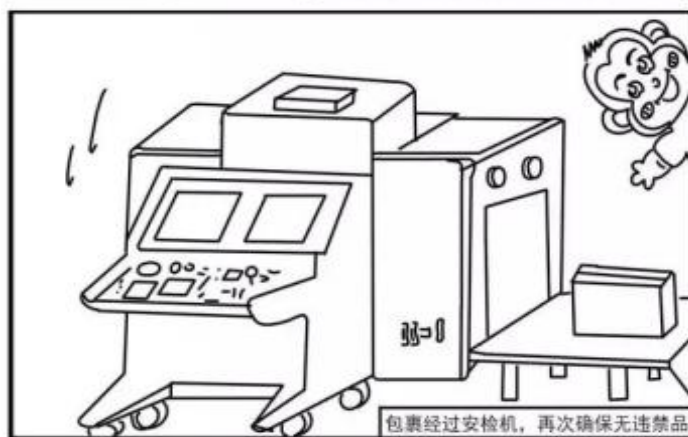

--	--	--	--	--	--

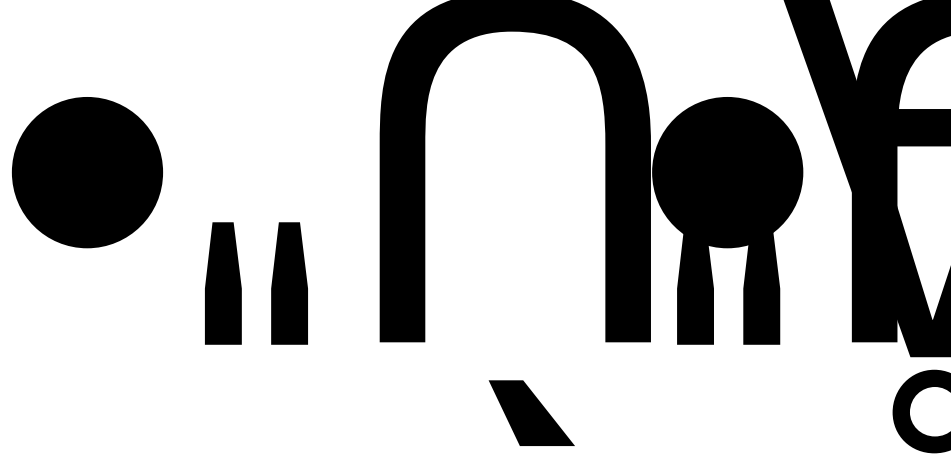

--	--	--	--	--	--

[想知道:中国成都理工大学校园快递具体在哪? 百度知道](#)

3个回答 - 提问时间: 2014年02月10日

最佳答案:韵达在银杏后面。宝盒、圆通、顺丰在电影院后面。中通、申通在图书馆下面。常用的是这几个。

[zhidao.baidu.com/link?... 2014-02-15](#) - 百度快照 - 80%好评

قَالَ قَوْلًا
مِنْ أَقْوَامٍ

قَالَ

--	--	--	--

--	--	--	--



--	--

